

MASTER CATALOG 2018

VOLUME ONE | **TURNING TOOLS**

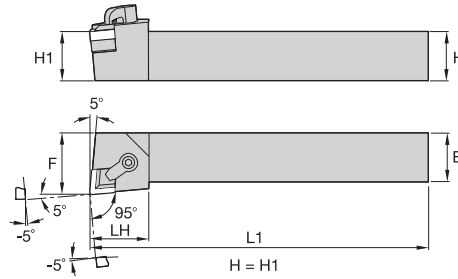
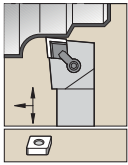

ISO/ANSI TURNING | GROOVING & CUT-OFF | THREADING | APPLICATION SPECIFIC

MCLN-C -5°

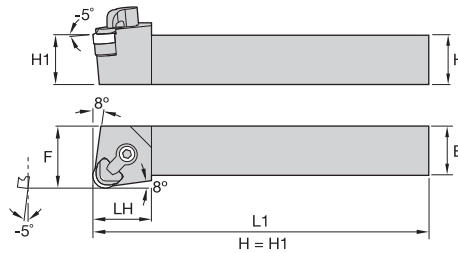
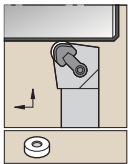

order number	catalog number	H	B	F	L1	LH	gage insert	shim	lock pin	hex	clamp	clamp screw	hex
right hand													
1096643	MCLNRC164D	1.00	1.00	1.250	6.00	1.25	CN..432	ICSN442	KL46L	3/32	CK21	STC20	1/8

MRGN-C

order number	catalog number	H	B	F	L1	LH	gage insert	shim	lock pin	hex	clamp	clamp screw	hex
right hand													
1096647	MRGNRC164D	1.00	1.00	1.250	6.00	1.25	RN..43	IRSN44	KL46L	3/32	CK21	STC20	1/8
1096648	MRGNRC204D	1.25	1.25	1.500	6.00	1.25	RN..43	IRSN44	KL46L	3/32	CK21	STC20	1/8
1096646	MRGNRC244D	1.50	1.50	2.000	6.00	1.25	RN..43	IRSN44	KL46L	3/32	CK21	STC20	1/8
left hand													
1096673	MRGNLC164D	1.00	1.00	1.250	6.00	1.25	RN..43	IRSN44	KL46L	3/32	CK21	STC20	1/8
1096674	MRGNLC204D	1.25	1.25	1.500	6.00	1.25	RN..43	IRSN44	KL46L	3/32	CK21	STC20	1/8
1096672	MRGNLC244D	1.50	1.50	2.000	6.00	1.25	RN..43	IRSN44	KL46L	3/32	CK21	STC20	1/8

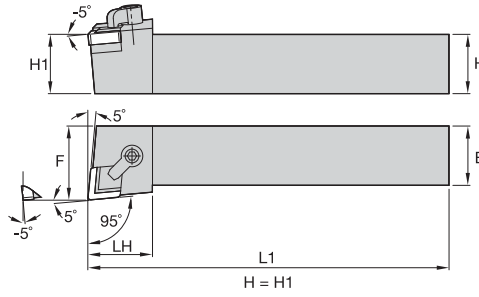
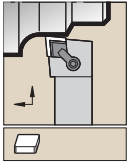

ISO/ANSI Turning



■ CCLN -5°



order number	catalog number	H	B	F	L1	LH	gage insert	shim	shim screw	hex	clamp	clamp screw	hex
right hand 1096722	CCLNR164	1.00	1.00	1.250	6.00	1.00	CN.422	SM396	S111	1/16	CK21	STC20	1/8
left hand 1096717	CCLNL164	1.00	1.00	1.250	6.00	1.00	CN.422	SM396	S111	1/16	CK21	STC20	1/8

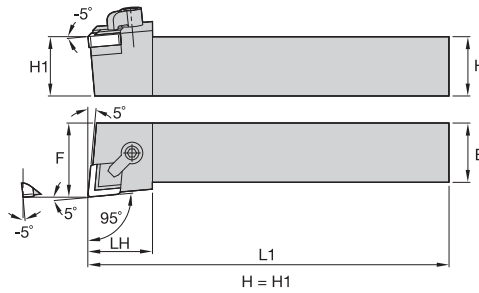
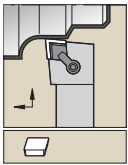

■ CCLN-P -5°



order number	catalog number	H	B	F	L1	LH	gage insert	shim	shim screw	clamp	clamp screw	hex
right hand 1096699	CCLNRP163D	1.00	1.00	1.250	6.00	1.25	CN.322	SM432	SL344	CK20	STC11	1/8
left hand 1096698	CCLNLP163D	1.00	1.00	1.250	6.00	1.25	CN.322	SM432	SL344	CK20	STC11	1/8

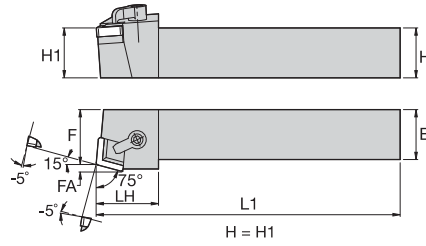
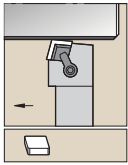

CCRN-P 15°

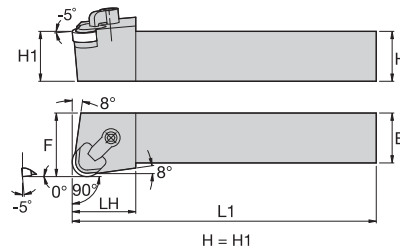
order number	catalog number	H	B	F	L1	LH	FA	gage insert	shim	shim screw	clamp	clamp screw	hex
right hand 1096701	CCRNRP163D	1.00	1.00	1.161	6.00	1.25	.09	CN.322	SM432	SL344	CK20	STC11	1/8

CRGN

order number	catalog number	H	B	F	L1	LH	gage insert	shim	shim screw	hex	clamp	clamp screw	hex
right hand 1096733	CRGNR123	.75	.75	.875	4.50	.75	RN.32	SM46	S111	1/16	CK6	STC5	3/32
1096734	CRGNR163	1.00	1.00	1.125	6.00	.75	RN.32	SM46	S111	1/16	CK6	STC5	3/32
1096735	CRGNR164	1.00	1.00	1.125	6.00	1.00	RN.42	SM218	S111	1/16	CK12	STC4	5/32
3870038	CRGNR244F	1.50	1.50	2.000	8.00	1.25	RNG45	SM45	S111	1/16	CK12	STC4	5/32
left hand 1096728	CRGNL123	.75	.75	.875	4.50	.75	RN.32	SM46	S111	1/16	CK6	STC5	3/32
1096729	CRGNL163	1.00	1.00	1.125	6.00	.75	RN.32	SM46	S111	1/16	CK6	STC5	3/32
1096730	CRGNL164	1.00	1.00	1.125	6.00	1.00	RN.42	SM218	S111	1/16	CK12	STC4	5/32

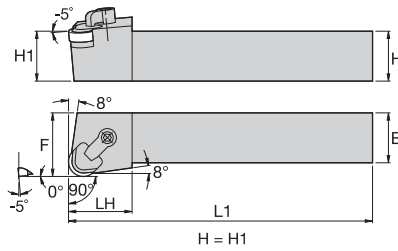
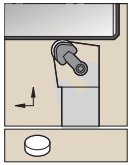
ISO/ANSI Turning



CRGN-P



order number	catalog number	H	B	F	L1	LH	gage insert	shim	shim screw	clamp	clamp screw	hex
right hand												
1096703	CRGNRP163D	1.00	1.00	1.250	6.00	.75	RNM32	SM434	SL344	CK20	STC20	1/8
1096705	CRGNRP164D	1.00	1.00	1.250	6.00	1.13	RN.42	SM437	SL344	CK28	STC4	5/32
1096707	CRGNRP204D	1.25	1.25	1.500	6.00	1.13	RN.42	SM437	SL344	CK28	STC4	5/32
left hand												
1096706	CRGNLP204D	1.25	1.25	1.500	6.00	1.13	RN.42	SM437	SL344	CK28	STC4	5/32

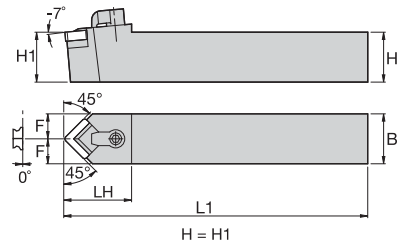
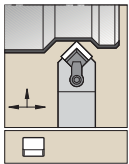

CSDN 45°

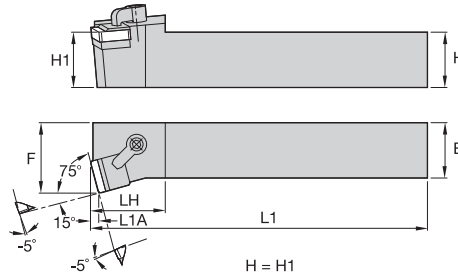
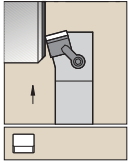

order number	catalog number	H	B	F	L1	LH	gage insert	shim	shim screw	hex	clamp	clamp screw	hex
1096772	CSDNN124	.75	.75	.375	4.50	1.31	SN.422	SM47	S111	1/16	CK10	STC4	5/32
1096739	CSDNN164	1.00	1.00	.500	6.00	1.31	SN.422	SM47	S111	1/16	CK9	STC4	5/32

CSKN 15°

order number	catalog number	H	B	F	L1	LH	L1A	gage insert	shim	shim screw	hex	clamp	clamp screw	hex
right hand 1096750	CSKNR856	1.25	1.00	1.190	6.00	1.50	.18	SN.633	SM216	S125	3/32	CK9	STC4	5/32

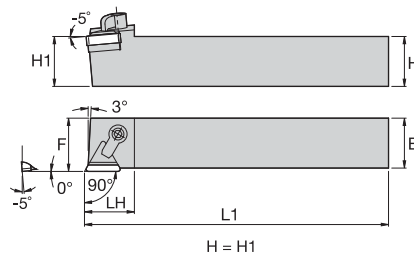
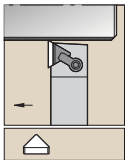
CTAN 0°

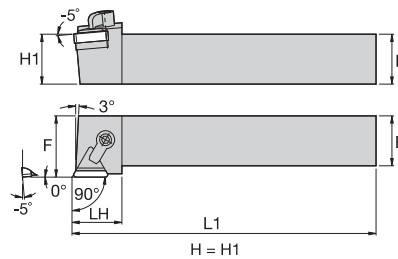
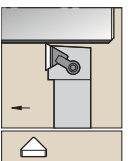

order number	catalog number	H	B	F	L1	LH	gage insert	shim	shim screw	hex	clamp	clamp screw	hex
right hand 1096798	CTANR123	.75	.75	.75	4.50	1.06	TN.322	SM48	S111	1/16	CK10	STC4	5/32

CTGN 0°

order number	catalog number	H	B	F	L1	LH	gage insert	shim	shim screw	hex	clamp	clamp screw	hex
right hand 1096887	CTGNR164	1.00	1.00	1.250	6.00	1.19	TN.432	SM26	S125	3/32	CK9	STC4	5/32

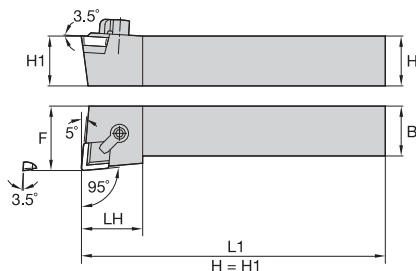
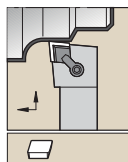

ISO/ANSI Turning



■ **CCLP -5°**



order number	catalog number	H	B	F	L1	LH	gage insert	shim	shim screw	hex	clamp	clamp screw	hex
right hand													
1096902	CCLPR084V	.50	.50	.750	3.50	1.00	CP.422	SM369	S19	1/16	CK7	STC9	3/32
1096903	CCLPR124B	.75	.75	1.000	4.50	1.25	CP.422	SM369	S111	1/16	CK13	STC8	5/32
1096904	CCLPR164C	1.00	1.00	1.250	5.00	1.25	CP.422	SM369	S111	1/16	CK12	STC4	5/32
left hand													
1096898	CCLPL124B	.75	.75	1.000	4.50	1.25	CP.422	SM369	S111	1/16	CK13	STC8	5/32
1096899	CCLPL164C	1.00	1.00	1.250	5.00	1.25	CP.422	SM369	S111	1/16	CK12	STC4	5/32

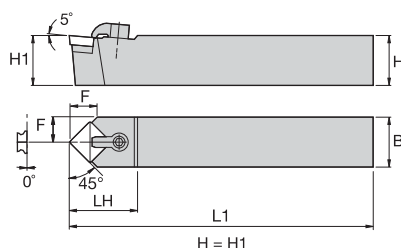
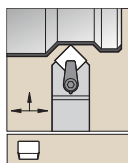

■ **CSDP 45°**



order number	catalog number	H	B	F	L1	LH	gage insert	shim	shim screw	hex	clamp	clamp screw	hex
1096909	CSDPN103	.63	.63	.312	4.50	.94	SP.322	SM120	SL344	—	CK7	STC5	3/32
1096910	CSDPN124	.75	.75	.375	4.50	1.38	SP.422	SM40	S111	1/16	CK10	STC8	5/32
1096912	CSDPN644	1.00	.75	.375	6.00	1.38	SP.422	SM40	S111	1/16	CK9	STC4	5/32
1096911	CSDPN164	1.00	1.00	.500	6.00	1.38	SP.422	SM40	S111	1/16	CK9	STC4	5/32
1096914	CSDPN856	1.25	1.00	.500	6.00	1.82	SP.633	SM36	S125	3/32	CK29	STC19	3/16

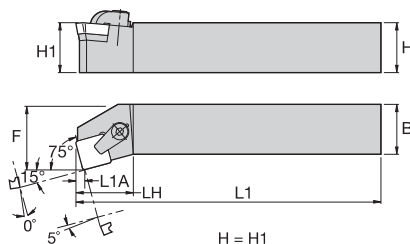
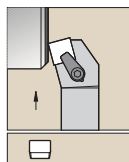

CSKP 15°

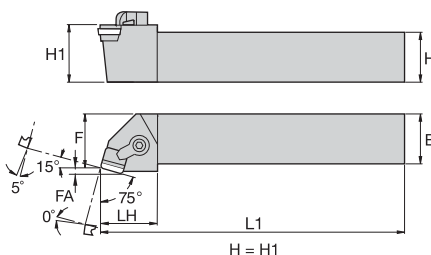
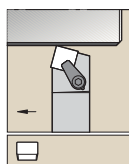
order number	catalog number	H	B	F	L1	LH	L1A	gage insert	shim	shim screw	hex	clamp	clamp screw	hex	
right hand															
1096920	CSKPR164D	1.00	1.00	1.250	6.00	1.13	.12	SP.422	SM40	S111	1/16	CK9	STC4	5/32	
left hand															
1096917	CSKPL164D	1.00	1.00	1.250	6.00	1.13	.12	SP.422	SM40	S111	1/16	CK9	STC4	5/32	

CSR 15°

order number	catalog number	H	B	F	L1	LH	FA	gage insert	shim	shim screw	hex	clamp	clamp screw	hex	
right hand															
1096932	CSRPR164D	1.00	1.00	1.048	6.00	1.19	.12	SP.422	SM40	S111	1/16	CK9	STC4	5/32	
1096934	CSRPR866E	1.50	1.00	1.060	7.00	1.50	.18	SP.633	SM36	S125	3/32	CK9	STC4	5/32	
left hand															
1096925	CSRPL124B	.75	.75	.855	4.50	1.19	.12	SP.422	SM40	S111	1/16	CK10	STC8	5/32	
1096926	CSRPL164D	1.00	1.00	1.048	6.00	1.19	.12	SP.422	SM40	S111	1/16	CK9	STC4	5/32	
1096927	CSRPL856D	1.25	1.00	1.060	6.00	1.50	.18	SP.633	SM36	S125	3/32	CK9	STC4	5/32	
1096928	CSRPL866E	1.50	1.00	1.060	7.00	1.50	.18	SP.633	SM36	S125	3/32	CK9	STC4	5/32	

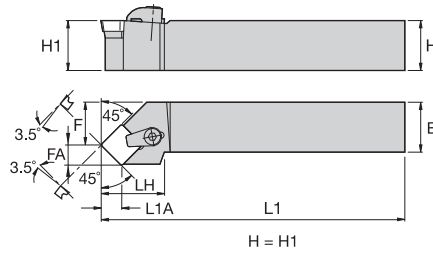
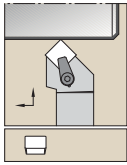
ISO/ANSI Turning



■ **CSSP 45°**



order number	catalog number	H	B	F	L1	LH	FA	L1A	gage insert	shim	shim screw	hex	clamp	clamp screw	hex
right hand															
1085234	CSwSPR164D	1.00	1.00	1.170	6.00	1.44	.34	.35	SP.422	SM40	S111	1/16	CK9	STC4	5/32
1096937	CSSPR854D	1.25	1.00	1.170	6.00	1.44	.34	.35	SP.422	SM40	S111	1/16	CK9	STC4	5/32
left hand															
1096691	CSSPL164D	1.00	1.00	1.170	6.00	1.44	.33	.35	SP.422	SM40	S111	1/16	CK9	STC4	5/32
1096935	CSSPL854D	1.25	1.00	1.170	6.00	1.44	.33	.35	SP.422	SM40	S111	1/16	CK9	STC4	5/32
1096693	CSSPL856D	1.25	1.00	1.020	6.00	1.50	.48	.53	SP.633	SM36	S125	3/32	CK9	STC4	5/32

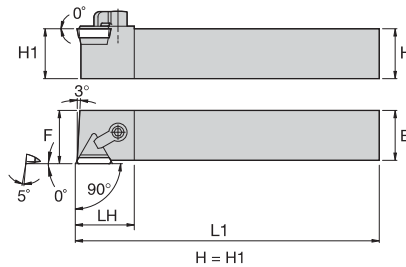
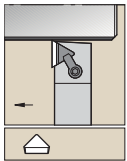

■ **CTAP 0°**



order number	catalog number	H	B	F	L1	LH	gage insert	shim	shim screw	hex	clamp	clamp screw	hex
right hand													
1096948	CTAPR082B	.50	.50	.500	4.50	.75	TP.221	SM119	SL344	—	CK19	STC9	3/32
1096949	CTAPR102B	.63	.63	.625	4.50	.75	TP.221	SM119	SL344	—	CK19	STC5	3/32
1096950	CTAPR123B	.75	.75	.750	4.50	1.06	TP.322	SM41	S111	1/16	CK10	STC8	5/32
1096951	CTAPR163D	1.00	1.00	1.000	6.00	1.06	TP.322	SM41	S111	1/16	CK9	STC4	5/32
1096952	CTAPR854D	1.25	1.00	1.000	6.00	1.12	TP.432	SM37	S125	3/32	CK9	STC4	5/32
left hand													
1096941	CTAPL123B	.75	.75	.750	4.50	1.06	TP.322	SM41	S111	1/16	CK10	STC8	5/32
1096946	CTAPL854D	1.25	1.00	1.000	6.00	1.12	TP.432	SM37	S125	3/32	CK9	STC4	5/32

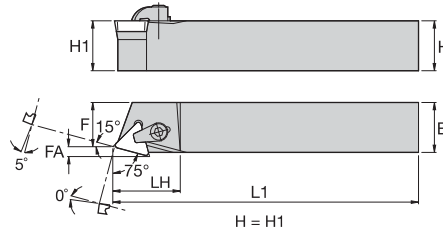
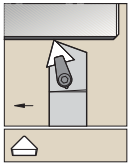

CTBP 15°

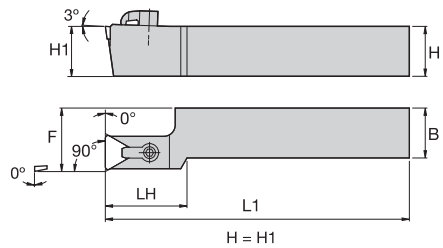
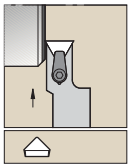
order number	catalog number	H	B	F	L1	LH	FA	gage insert	shim	shim screw	hex	clamp	clamp screw	hex	
right hand															
1096959	CTBPR123B	.75	.75	.600	4.50	1.19	.15	TP.322	SM41	S111	1/16	CK10	STC8	5/32	
1096960	CTBPR163D	1.00	1.00	.850	6.00	1.19	.15	TP.322	SM41	S111	1/16	CK9	STC4	5/32	
left hand															
1096955	CTBPL123B	.75	.75	.600	4.50	1.19	.15	TP.322	SM41	S111	1/16	CK10	STC8	5/32	

CTCPL 0°

order number	catalog number	H	B	F	L1	LH	gage insert	shim	shim screw	hex	clamp	clamp screw	hex
right hand													
1096976	CTCPR123B	.75	.75	1.000	4.50	1.50	TP.322	SM41	S111	1/16	CK23	STC11	1/8
1096977	CTCPR163C	1.00	1.00	1.250	5.00	1.50	TP.322	SM41	S111	1/16	CK23	STC11	1/8
1096978	CTCPR164C	1.00	1.00	1.250	5.00	1.62	TP.432	SM37	S125	3/32	CK13	STC4	5/32
1096979	CTCPR164D	1.00	1.00	1.250	6.00	1.62	TP.432	SM37	S125	3/32	CK13	STC4	5/32
1096980	CTCPR204D	1.25	1.25	1.500	6.00	1.62	TP.432	SM37	S125	3/32	CK13	STC4	5/32
1096982	CTCPR244D	1.50	1.50	2.000	6.00	3.00	TP.432	SM37	S125	3/32	CK13	STC4	5/32
left hand													
1096963	CTCPL163C	1.00	1.00	1.250	5.00	1.50	TP.322	SM41	S111	1/16	CK23	STC11	1/8
1096965	CTCPL164D	1.00	1.00	1.250	6.00	1.62	TP.432	SM37	S125	3/32	CK13	STC4	5/32
1096966	CTCPL204D	1.25	1.25	1.500	6.00	1.62	TP.432	SM37	S125	3/32	CK13	STC4	5/32
1096968	CTCPL244D	1.50	1.50	2.000	6.00	3.00	TP.432	SM37	S125	3/32	CK13	STC4	5/32

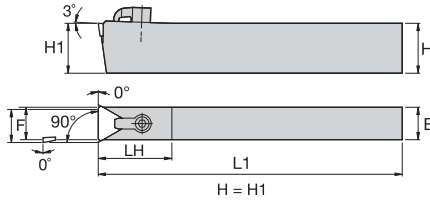
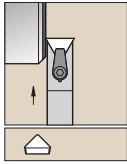
ISO/ANSI Turning



■ CTCPN 0°



order number	catalog number	H	B	F	L1	LH	gage insert	shim	shim screw	hex	clamp	clamp screw	hex
1096972	CTCPN443	1.00	.50	.542	8.00	1.19	TP.322	SM41	S111	1/16	CK23	STC11	1/8
1096971	CTCPN124	.75	.75	.782	6.00	1.31	TP.432	SM37	S125	3/32	CK13	STC8	5/32
1096973	CTCPN644	1.00	.75	.782	8.00	1.31	TP.432	SM37	S125	3/32	CK13	STC4	5/32
1096974	CTCPN664	1.50	.75	.782	8.00	1.31	TP.432	SM37	S125	3/32	CK13	STC4	5/32

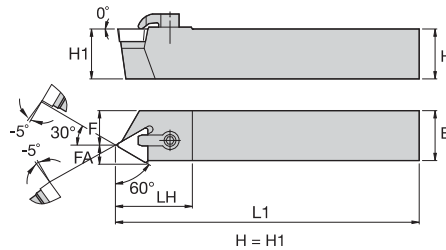
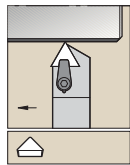

■ CTEP 30°

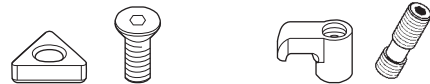

order number	catalog number	H	B	F	L1	LH	FA	gage insert	shim	shim screw	hex	clamp	clamp screw	hex
right hand														
1096985	CTEPR123B	.75	.75	.460	4.50	1.25	.28	TP.322	SM41	S111	1/16	CK10	STC8	5/32
1096992	CTEPR163D	1.00	1.00	.700	6.00	1.25	.28	TP.322	SM41	S111	1/16	CK9	STC4	5/32
1096993	CTEPR854D	1.25	1.00	.610	6.00	1.31	.39	TP.432	SM37	S125	3/32	CK9	STC4	5/32
left hand														
1096989	CTEPL854D	1.25	1.00	.610	6.00	1.31	.39	TP.432	SM37	S125	3/32	CK9	STC4	5/32

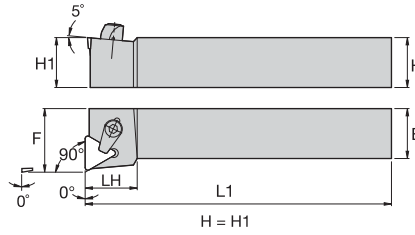
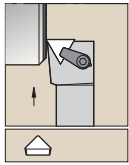
CTFP 0°

order number	catalog number	H	B	F	L1	LH	gage insert	shim	shim screw	hex	clamp	clamp screw	hex
right hand													
1097008	CTFPR082V	.50	.50	.750	3.50	.56	TP.221	SM119	SL344	—	CK19	STC9	3/32
1097011	CTFPR123B	.75	.75	1.000	4.50	1.12	TP.322	SM41	S111	1/16	CK10	STC8	5/32
1097013	CTFPR163D	1.00	1.00	1.250	6.00	1.12	TP.322	SM41	S111	1/16	CK9	STC4	5/32
1097014	CTFPR164C	1.00	1.00	1.250	5.00	1.25	TP.432	SM37	S125	3/32	CK9	STC4	5/32
1097015	CTFPR164D	1.00	1.00	1.250	6.00	1.25	TP.432	SM37	S125	3/32	CK9	STC4	5/32
1097018	CTFPR854D	1.25	1.00	1.250	6.00	1.25	TP.432	SM37	S125	3/32	CK9	STC4	5/32
1097016	CTFPR204D	1.25	1.25	1.500	6.00	1.25	TP.432	SM37	S125	3/32	CK9	STC4	5/32
left hand													
1096997	CTFPL123B	.75	.75	1.000	4.50	1.12	TP.322	SM41	S111	1/16	CK10	STC8	5/32
1096999	CTFPL163D	1.00	1.00	1.250	6.00	1.12	TP.322	SM41	S111	1/16	CK9	STC4	5/32
1097001	CTFPL164D	1.00	1.00	1.250	6.00	1.25	TP.432	SM37	S125	3/32	CK9	STC4	5/32
1097004	CTFPL854D	1.25	1.00	1.250	6.00	1.25	TP.432	SM37	S125	3/32	CK9	STC4	5/32



ISO/ANSI Turning

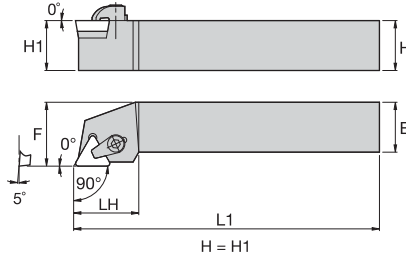
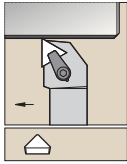

■ CTGP 0°



order number	catalog number	H	B	F	L1	LH	gage insert	shim	shim screw	hex	clamp	clamp screw	hex
right hand													
1096696	CTGPR082B	.50	.50	.750	4.50	.75	TP.221	SM119	SL344	—	CK19	STC9	3/32
1097035	CTGPR102B	.63	.63	.875	4.50	.75	TP.221	SM119	SL344	—	CK19	STC9	3/32
1097036	CTGPR123A	.75	.75	1.000	4.00	1.13	TP.322	SM41	S111	1/16	CK10	STC8	5/32
1097037	CTGPR123B	.75	.75	1.000	4.50	1.13	TP.322	SM41	S111	1/16	CK10	STC8	5/32
1097038	CTGPR163C	1.00	1.00	1.250	5.00	1.13	TP.322	SM41	S111	1/16	CK9	STC4	5/32
1097039	CTGPR163D	1.00	1.00	1.250	6.00	1.13	TP.322	SM41	S111	1/16	CK9	STC4	5/32
1097041	CTGPR164C	1.00	1.00	1.250	5.00	1.25	TP.432	SM37	S125	3/32	CK9	STC4	5/32
1097042	CTGPR164D	1.00	1.00	1.250	6.00	1.25	TP.432	SM37	S125	3/32	CK9	STC4	5/32
1097043	CTGPR204D	1.25	1.25	1.500	6.00	1.25	TP.432	SM37	S125	3/32	CK9	STC4	5/32
left hand													
1097021	CTGPL102B	.63	.63	.875	4.50	.75	TP.221	SM119	SL344	—	CK19	STC9	3/32
1097022	CTGPL123B	.75	.75	1.000	4.50	1.13	TP.322	SM41	S111	1/16	CK10	STC8	5/32
1097023	CTGPL163C	1.00	1.00	1.250	5.00	1.13	TP.322	SM41	S111	1/16	CK9	STC4	5/32
1097024	CTGPL163D	1.00	1.00	1.250	6.00	1.13	TP.322	SM41	S111	1/16	CK9	STC4	5/32
1097026	CTGPL164D	1.00	1.00	1.250	6.00	1.25	TP.432	SM37	S125	3/32	CK9	STC4	5/32
1097027	CTGPL204D	1.25	1.25	1.500	6.00	1.25	TP.432	SM37	S125	3/32	CK9	STC4	5/32

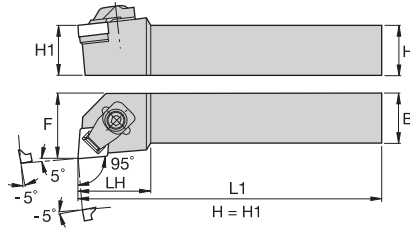
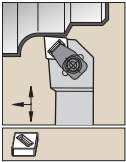

■ CCLN-MX -5°



order number	catalog number	H	B	F	L1	LH	gage insert	shim	shim screw	Torx	clamp assembly	Torx
right hand												
1540438	CCLNR164DMX5	1.00	1.00	1.250	6.00	1.25	CN.X452	552.221	554.260	T20	551.326	T25
1540445	CCLNR204DMX5	1.25	1.25	1.500	6.00	1.25	CN.X452	552.221	554.260	T20	551.326	T25
left hand												
1540443	CCLNL164DMX5	1.00	1.00	1.250	6.00	1.25	CN.X452	552.221	554.260	T20	551.326	T25
1540447	CCLNL204DMX5	1.25	1.25	1.500	6.00	1.25	CN.X452	552.221	554.260	T20	551.326	T25

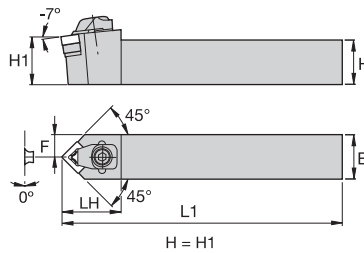
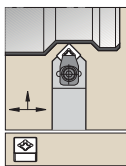

■ CSDN-MX 45°



order number	catalog number	H	B	F	L1	LH	gage insert	shim	shim screw	Torx	clamp assembly	Torx
1540492	CSDNN164DMX5	1.00	1.00	.500	6.00	1.38	SN.X452	552.232	554.260	T20	551.326	T25

ISO/ANSI Turning

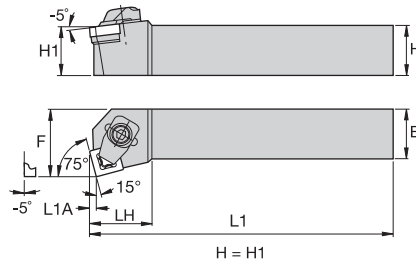
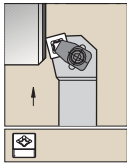

■ **CSKN-MX 15°**



order number	catalog number	H	B	F	L1	LH	L1A	gage insert	shim	shim screw	Torx	clamp assembly	Torx
right hand													
1540495	CSKNR164DMX5	1.00	1.00	1.250	6.00	1.06	.12	SN.X452	552.232	554.260	T20	551.326	T25
left hand													
1541374	CSKNL164DMX5	1.00	1.00	1.250	6.00	1.06	.12	SN.X452	552.232	554.260	T20	551.326	T25

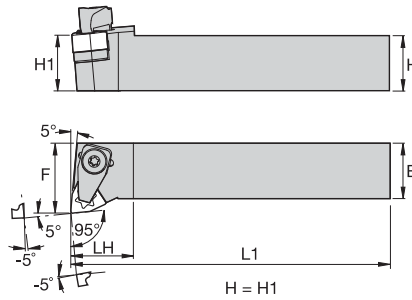
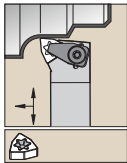

■ **CWLN-MX -5°**

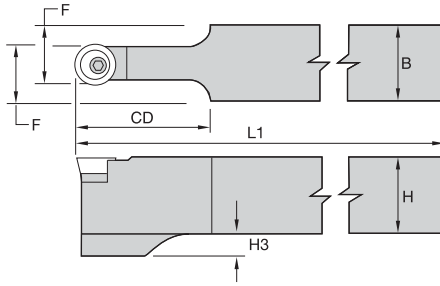
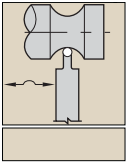

order number	catalog number	H	B	F	L1	LH	gage insert	shim	shim screw	Torx	clamp assembly	Torx
right hand												
1873125	CWLN164DMX5	1.00	1.00	1.250	6.00	1.12	WN.X452	552.210	554.260	T20	551.326	T25
1873184	CWLN204DMX5	1.25	1.25	1.500	6.00	1.12	WN.X452	552.210	554.260	T20	551.326	T25
left hand												
1873128	CWLN164DMX5	1.00	1.00	1.250	6.00	1.12	WN.X452	552.210	554.260	T20	551.326	T25
1873185	CWLN204DMX5	1.25	1.25	1.500	6.00	1.12	WN.X452	552.210	554.260	T20	551.326	T25

Bevel Lock



order number	catalog number	H	B	F	L1	CD	H3	gage insert	shim	lock pin	hex
1095802	PROON164D	1.00	1.00	.750	6.00	1.86	—	RC..43	SMRN42B	BP46	3/32
1095803	PROON204D	1.25	1.25	.875	6.00	1.88	—	RC..43	SMRN42B	BP46	3/32
1095806	PROON244D	1.50	1.50	1.000	6.00	1.88	—	RC..43	SMRN42B	BP46	3/32
1095804	PROON206D	1.25	1.25	1.000	6.00	2.36	—	RC..64	SMRN63B	BP68	1/8
1095808	PROON246	1.50	1.50	1.125	8.00	2.37	—	RC..64	SMRN63B	BP68	1/8
1095805	PROON208D	1.25	1.25	1.125	6.00	2.32	.25	RC..86	SMRN84B	BP812	9/64

NOTE: Order numbers 1095802, 1095803, and 1095806 accept RCGH-43 inserts only. RCMH-43 inserts will not fit.

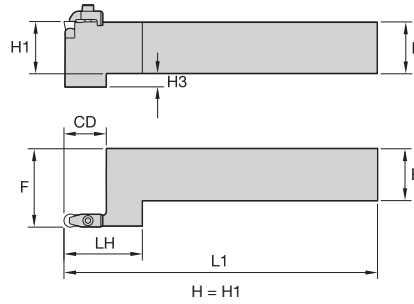
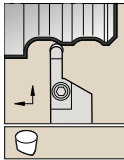
ISO/ANSI Turning

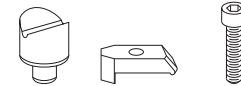

411-VRS



order number	catalog number	H	B	F	L1	LH	CD	H3	gage insert	nest	clamp	clamp screw	hex
right hand													
1298873	4111492VRS	1.00	1.00	1.500	6.00	1.50	.75	.25	R..V23	NST1	CM214	MS1321	2.5 mm
1298876	4111573VRS	1.00	1.00	1.000	6.00	1.19	1.13	.25	R..V35	NST2	CM219	CS412	3.5 mm
1156449	4111593VRS	1.25	1.25	1.250	6.00	1.19	1.13	—	R..V35	NST2	CM219	CS412	3.5 mm
1298882	4111654VRS	1.00	1.00	1.000	6.00	1.56	1.50	.25	R..V45	NST3	CM216	CS412	3.5 mm
1298884	4111674VRS	1.25	1.25	1.250	6.00	1.56	1.50	—	R..V45	NST3	CM216	CS412	3.5 mm
left hand													
1298879	4111603VRS	1.25	1.25	1.250	6.00	1.19	1.13	—	R..V35	NST2	CM219	CS412	3.5 mm
1298883	4111664VRS	1.00	1.00	1.000	6.00	1.50	1.50	.25	R..V45	NST3	CM216	CS412	3.5 mm

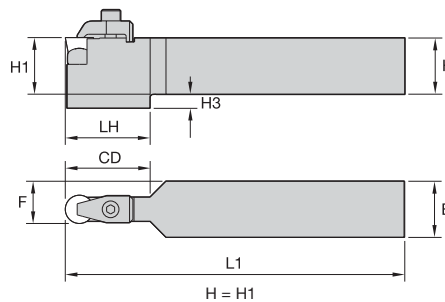
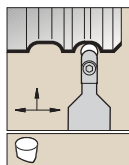

CRDP

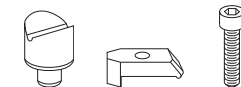

order number	catalog number	H	B	F	L1	LH	CD	H3	gage insert	nest	clamp	clamp screw	hex
3641572	CRDPN162DV	1.00	1.00	.496	6.00	—	.75	—	R..V23	NST1	CM214	MS1321	2.5 mm
3641593	CRDPN163DV	1.00	1.00	.496	6.00	—	1.13	—	R..V35	NST2	CM219	CS412	3.5 mm
3641594	CRDPN203DV	1.25	1.25	.621	6.00	—	1.13	—	R..V35	NST2	CM219	CS412	3.5 mm
3641595	CRDPN164DV	1.00	1.00	.496	6.00	1.50	1.50	.25	R..V45	NST3	CM216	CS412	3.5 mm
3641597	CRDPN204DV	1.25	1.25	.621	6.00	—	1.50	—	R..V45	NST3	CM216	CS412	3.5 mm

NOTE: CRDP toolholders are able to use RPGX and RCGX insert styles.

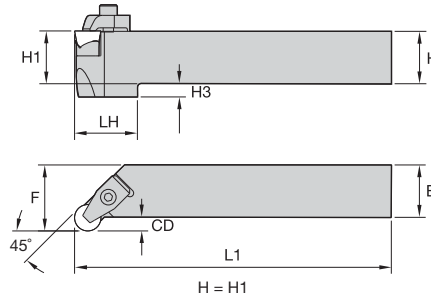
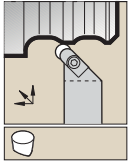

■ CRGP

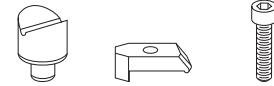

order number	catalog number	H	B	F	L1	CD	gage insert	nest	clamp	clamp screw	hex
right hand											
3641603	CRGPR162DV	1.00	1.00	1.250	6.00	.25	R..V23	NST1	CM214	MS1321	2.5 mm
3641611	CRGPR204DV	1.25	1.25	1.500	6.00	.25	R..V45	NST3	CM216	CS412	3.5 mm
left hand											
3641604	CRGPL162DV	1.00	1.00	1.250	6.00	.25	R..V23	NST1	CM214	MS1321	2.5 mm
3641608	CRGPL203DV	1.25	1.25	1.500	6.00	.25	R..V35	NST2	CM219	CS412	3.5 mm

NOTE: CRGP toolholders are able to use RPGX and RCGX insert styles.

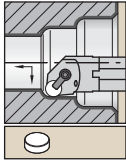

Steel shank with through coolant.

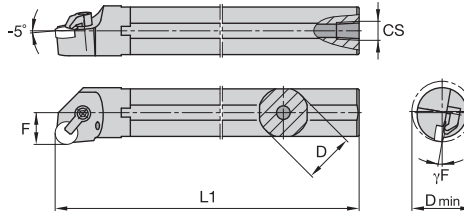

■ **A-CRGN**

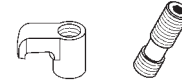

order number	catalog number	D	D min	F	L1	CS	γF°	gage insert	clamp	clamp screw	hex
right hand 1094792	A16CRGNR3	1.000	1.200	.640	12.00	1/4-18 NPT	-10.0	RN.32	CK7LP	STC9	3/32
left hand 1094793	A16CRGNL3	1.000	1.200	.640	12.00	1/4-18 NPT	-10.0	RN.32	CK7LP	STC9	3/32

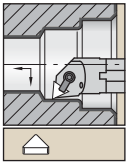

Steel shank with through coolant.

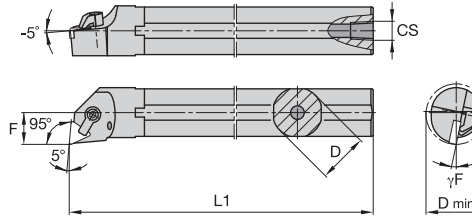

■ **A-CTLN-5°**

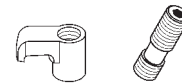

order number	catalog number	D	D min	F	L1	CS	γF°	gage insert	clamp	clamp screw	hex
right hand 1094818	A10SCTLNR2	.625	.770	.406	10.00	1/8-27 NPT	-12.0	TN.221	CK7LP	STC9	3/32
left hand 1094816	A08RCTLNR2	.500	.600	.312	8.00	1/16-27 NPT	-14.0	TN.221	CK27	STC27	5/64
1094819	A10CTLNL2	.625	.770	.406	10.00	1/8-27 NPT	-12.0	TN.221	CK7LP	STC9	3/32

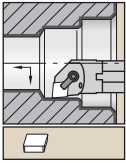

Steel shank with through coolant.

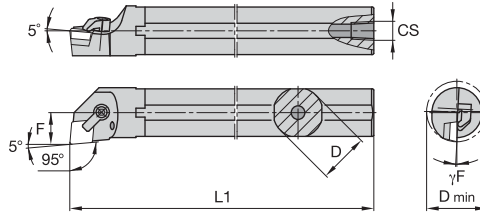
A-CCLP-5°

order number	catalog number	D	D min	F	L1	CS	γF°	gage insert	shim	shim screw	hex	clamp	clamp screw	hex	
right hand															
1094896	A16CCLPR4	1.000	1.200	.640	12.00	1/4-18 NPT	-3.0	CP.422	SM369	S19	1/16	CK20	STC11	1/8	
1094900	A24CCLPR4	1.500	1.760	.890	14.00	1/4-18 NPT	.0	CP.422	SM369	S19	1/16	CK22	STC26	1/8	

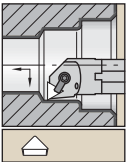

Steel shank with through coolant.

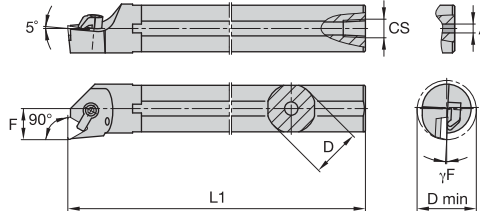

A-CTFP 0°

order number	catalog number	D	D min	F	L1	A	CS	γF°	gage insert	shim	shim screw	hex	clamp	clamp screw	hex
right hand															
1094872	A06RCTFPR2	.375	.480	.250	6.00	.13	—	-3.0	TPG.2151	—	—	—	CK27	STC27	5/64
1094874	A08RCTFPR2	.500	.600	.312	8.00	.16	1/16-27 NPT	-3.0	TP.221	—	—	—	CK27	STC27	5/64
1094876	A10SCTFPR2	.625	.770	.406	10.00	.16	1/8-27 NPT	-4.0	TP.221	—	—	—	CK19	STC9	3/32
1094878	A12SCTFPR3	.750	.930	.500	10.00	.16	1/8-27 NPT	.0	TP.322	—	—	—	CK7	STC9	3/32
1094880	A16TCTFPR3	1.000	1.200	.640	12.00	—	1/4-18 NPT	.0	TP.322	—	—	—	CK20	STC11	1/8
1094882	A20UCTFPR3	1.250	1.470	.765	14.00	.25	1/4-18 NPT	-3.0	TP.322	SM41	S19	1/16	CK10	STC8	5/32
1094884	A24CTFPR3	1.500	1.760	.890	14.00	.25	1/4-18 NPT	-3.0	TP.322	SM41	S19	1/16	CK10	STC8	5/32
1094888	A24CTFPR4	1.500	1.760	.890	14.00	.25	1/4-18 NPT	-3.0	TP.432	SM37	S125	3/32	CK10	STC8	5/32
1094892	A32CTFPR4	2.000	2.400	1.281	16.00	.25	1/4-18 NPT	-3.0	TP.432	SM37	S125	3/32	CK9	STC4	5/32
left hand															
1094875	A08RCTFPL2	.500	.600	.312	8.00	.16	1/16-27 NPT	-3.0	TP.221	—	—	—	CK27	STC27	5/64
1094877	A10CTFPL2	.625	.770	.406	10.00	.16	1/8-27 NPT	-4.0	TP.221	—	—	—	CK19	STC9	3/32
1094879	A12SCTFPL3	.750	.930	.500	10.00	.16	1/8-27 NPT	.0	TP.322	—	—	—	CK7	STC9	3/32
1094889	A24CTFPL4	1.500	1.760	.890	14.00	—	1/4-18 NPT	-3.0	TP.432	SM37	S125	3/32	CK10	STC8	5/32

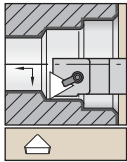
ISO/ANSI Turning

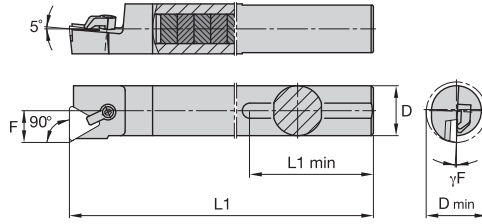

DeVibrator shank.



■ **B-CTFP 0°**



order number	catalog number	D	D min	F	L1	L1 min	γF°	gage insert						
									shim	shim screw	hex	clamp	clamp screw	hex
1095829	B10CTFPR2	.625	.770	.406	10.00	5.25	.0	TP.221	—	—	—	CK19	STC9	3/32
1095830	B12CTFPR3	.750	.930	.500	10.00	5.75	.0	TP.322	—	—	—	CK7	STC9	3/32
1095831	B14CTFPR3	.875	1.060	.516	10.00	6.25	.0	TP.322	—	—	—	CK20	STC11	1/8
1095832	B16CTFPR3	1.000	1.200	.640	12.00	6.50	.0	TP.322	—	—	—	CK20	STC11	1/8
1095833	B20CTFPR3	1.250	1.470	.765	14.00	8.25	-3.0	TP.322	SM41	S111	1/16	CK10	STC8	5/32
1095834	B24CTFPR4	1.500	1.760	.890	15.50	9.75	-3.0	TP.432	SM37	S125	3/32	CK10	STC8	5/32
1095836	B32CTFPR4	2.000	2.400	1.281	21.50	12.25	-3.0	TP.432	SM37	S125	3/32	CK9	STC4	5/32

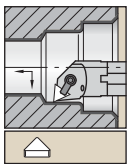

Steel shank with through coolant.

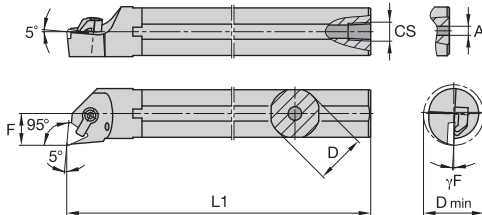

■ **A-CTLP -5°**

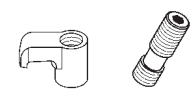

order number	catalog number	D	D min	F	L1	A	CS	γF°	gage insert			
										clamp	clamp screw	hex
right hand												
1094904	A06MCTLPR2	.375	.480	.250	6.00	.13	—	-3.0	TP.2151	CK27	STC27	5/64
1094906	A08RCTLPR2	.500	.600	.312	8.00	.16	1/16-27 NPT	-3.0	TP.221	CK27	STC27	5/64
1094908	A12SCTLPR3	.750	.930	.500	10.00	.16	1/8-27 NPT	.0	TP.322	CK7	STC9	3/32
1094910	A16CTLPR3	1.000	1.220	.640	12.00	—	1/4-18 NPT	.0	TP.322	CK20	STC11	1/8
left hand												
1094907	A08RCTLPL2	.500	.600	.312	8.00	.16	1/16-27 NPT	-3.0	TP.221	CK27	STC27	5/64
3994022	A10SCTLPL2	.625	.770	.406	10.00	.16	1/8-27 NPT	-3.0	TP.221	CK19	STC9	3/32
1094909	A12SCTLPL3	.750	.930	.500	10.00	.16	1/8-27 NPT	.0	TP.322	CK7	STC9	3/32
1094863	A16CTLPL3	1.000	1.220	.640	12.00	—	1/4-18 NPT	.0	TP.322	CK20	STC11	1/8

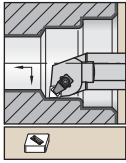

Steel shank with through coolant.

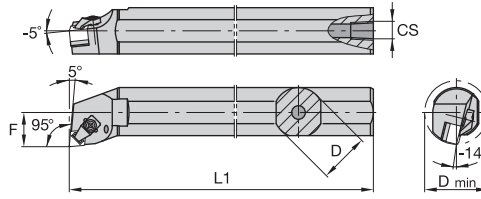

■ A-CCLN-MX -5°



order number	catalog number	D	D min	F	L1	CS	gage insert	shim	shim screw	Torx	clamp assembly	Torx
right hand												
1540531	A24CCLNR4MX5	1.500	2.165	.890	14.00	1/4-18 NPT	CN.X452	552.221	554.260	T20	551.326	T25
1540552	A32CCLNR4MX5	2.000	2.323	1.281	16.00	1/4-18 NPT	CN.X452	552.221	554.260	T20	551.326	T25
left hand												
1541742	A24CCLNL4MX5	1.500	2.165	.890	14.00	1/4-18 NPT	CN.X452	552.221	554.260	T20	551.326	T25
1541743	A32CCLNL4MX5	2.000	2.323	1.281	16.00	1/4-18 NPT	CN.X452	552.221	554.260	T20	551.326	T25

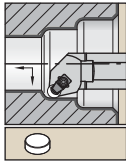

Steel shank with through coolant.

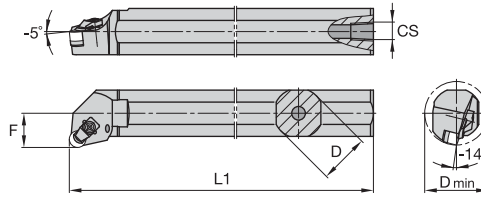

■ A-CRGN-MN



order number	catalog number	D	D min	F	L1	CS	gage insert	shim	shim screw	Torx	clamp assembly	Torx
right hand												
1558021	A32CRGNR4MN5	2.000	2.559	1.281	16.00	1/4-18 NPT	RN.45	552.230	554.260	T20	551.343	T25



ISO/ANSI Turning

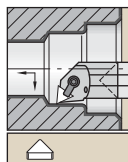

Carbide shank with through coolant.

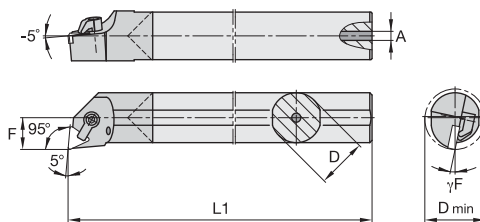

■ E-CTLN-5°



order number	catalog number	D	D min	F	L1	A	gage insert	clamp	clamp screw	hex
right hand										
1152668	E12CTLNR2	.750	.930	.500	10.00	.28	TN.221	CK7LP	STC9	3/32

Kendex Positive Inserts

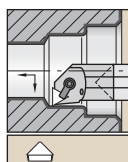

Carbide shank with through coolant.

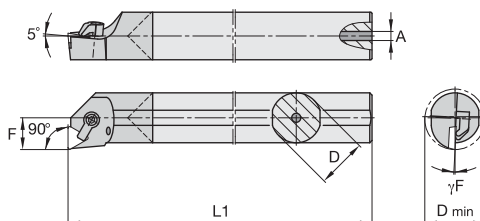

■ E-CTFP 0°



order number	catalog number	D	D min	F	L1	A	γF°	gage insert	clamp	clamp screw	hex
right hand											
1152584	E08KCTFPR2	.500	.600	.312	5.00	.19	-3.0	TP.221	CK27	STC27	5/64
1152586	E08RCTFPR2	.500	.600	.312	8.00	.19	-3.0	TP.221	CK27	STC27	5/64
1152588	E10MCTFPR2	.625	.770	.406	6.00	.22	.0	TP.221	CK19	STC9	3/32
1152590	E10SCTFPR2	.625	.770	.406	10.00	.22	.0	TP.221	CK19	STC9	3/32
1152592	E12QCTFPR3	.750	.930	.500	7.00	.28	.0	TP.322	CK7	STC9	3/32
1152594	E12SCTFPR3	.750	.930	.500	10.00	.28	.0	TP.322	CK7	STC9	3/32
1152598	E16TCTFPR3	1.000	1.200	.640	12.00	.31	.0	TP.322	CK20	STC11	1/8
left hand											
1152593	E12QCTFPL3	.750	.930	.500	7.00	.28	.0	TP.322	CK7	STC9	3/32
1152595	E12SCTFPL3	.750	.930	.500	10.00	.28	.0	TP.322	CK7	STC9	3/32

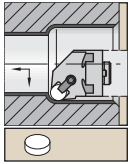

With through coolant.

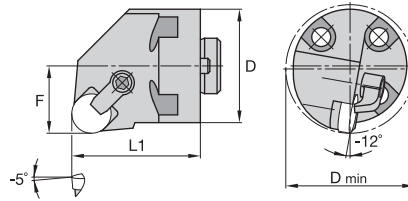
H-CRGN

order number	catalog number	D	D min	F	L1	gage insert	shim	shim screw	clamp	clamp screw	hex
right hand											
1095001	H24CRGNR4	1.500	1.760	.890	1.63	RN.42	SM437	SL344	CK7LP	STC9	3/32
1095003	H32CRGNR4	2.000	2.400	1.281	1.63	RN.42	SM437	SL344	CK7LP	STC9	3/32

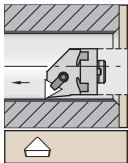

With through coolant.

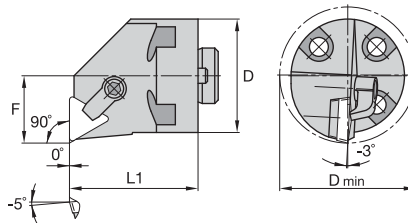
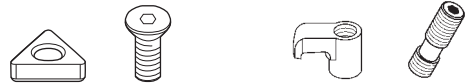
H-CTFP 0°

order number	catalog number	D	D min	F	L1	gage insert	shim	shim screw	hex	clamp	clamp screw	hex
right hand												
1095321	H20CTFPR3W	1.250	1.470	.765	1.63	TP.322	SM41	S111	1/16	CK10	STC8	5/32
1095542	H40CTFPR4W	2.500	3.030	1.531	1.63	TP.432	SM37	S125	3/32	CK10	STC4	5/32



ISO/ANSI Turning

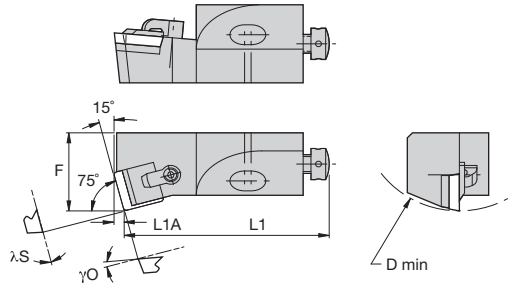

■ **CSKP 15°**

order number	catalog number	D min	F	L1	L1A	λS°	γ0°	gage insert
right hand 1261328	CSKPR12CA4	1.969	.787	2.17	.12	.0	5.0	SP..120308/SP..422

■ **Spare Parts**



D min	shim	clamp	clamp screw	hex	radial adjusting screw	hex	axial adjusting screw	mounting screw	hex	washer
1.969	—	CKM34	STCM38	2 mm	KUAM22	2 mm	KUAM31	191.406	4 mm	CSWM 060 050

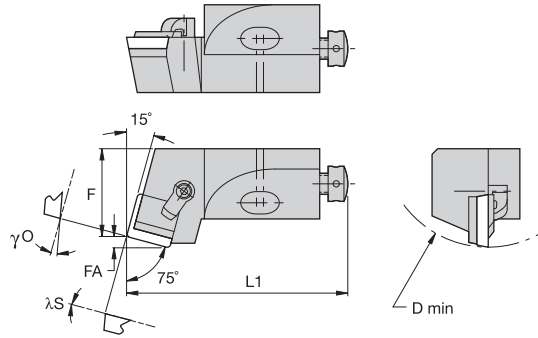

■ **CSRPR -15°**

order number	catalog number	D min	F	FA	L1	λS°	γO°	gage insert
right hand								
3331132	CSRPR10CA3	1.575	.551	.087	1.97	.0	.0	SP..090308/SP..322

■ **Spare Parts**



D min	clamp	clamp screw	hex	radial adjusting screw	hex	axial adjusting screw	mounting screw	hex	washer
1.575	CKM34	STCM38	2 mm	KUAM28	2 mm	KUAM30	191.405	4 mm	CSWM 060 050

ISO/ANSI Turning

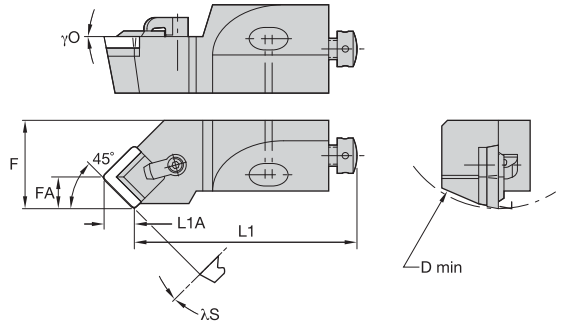

■ **CSSP 45°**

order number	catalog number	D min	F	FA	L1	L1A	λS°	γ0°	gage insert
right hand									
1261379	CSSPR10CA3	1.575	.551	.254	1.73	.24	.0	.0	SP..090308/SP..322
left hand									
3331143	CSSPL10CA3	1.575	.551	.254	1.73	.24	.0	.0	SP..090308/SP..322

NOTE: Select spare parts based off of D min and insert size selected.

■ **Spare Parts**



D min	shim	clamp	clamp screw	hex	radial adjusting screw	hex	axial adjusting screw	mounting screw	hex	washer
1.575	—	CKM34	STCM38	2 mm	KUAM28	2 mm	KUAM30	191.405	4 mm	CSWM 060 050

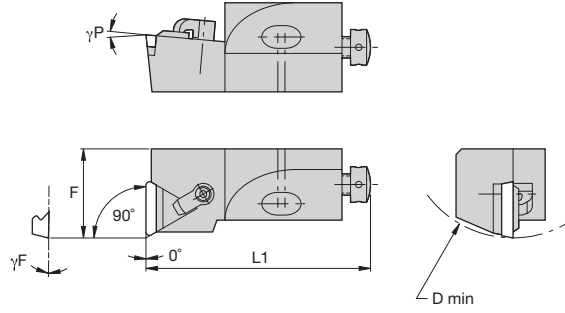
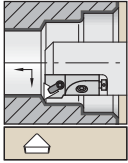

CTFP 0°

order number	catalog number	D min	F	L1	γ_F°	γ_P°	gage insert
right hand							
2116588	CTFPR10CA2	1.575	.551	1.97	.0	5.0	TP..110304/TP..221
1746442	CTFPR12CA3	1.969	.787	2.17	.0	5.0	TP..160308/TP..322
2582207	CTFPR20CA4	2.756	.984	2.76	.0	5.0	TP..220408/TP..432
left hand							
2114034	CTFPL10CA2	1.575	.551	1.97	.0	5.0	TP..110304/TP..221

Spare Parts

D min	shim	shim screw	hex	clamp	clamp screw	hex	radial adjusting screw	hex	axial adjusting screw	mounting screw	mounting screw	hex	washer
1.575	—	—	—	CKM34	STCM38	2 mm	KUAM28	2 mm	KUAM30	191.405	—	4 mm	CSWM 060 050
1.969	—	—	—	CKM34	STCM38	2 mm	KUAM22	2 mm	KUAM31	—	191.406	4 mm	CSWM 060 050
2.756	SM837	MS125	2.5 mm	CKM35	STCM8	4 mm	KUAM25	2.5 mm	KUAM32	—	191.407	5 mm	CSWM 080 050

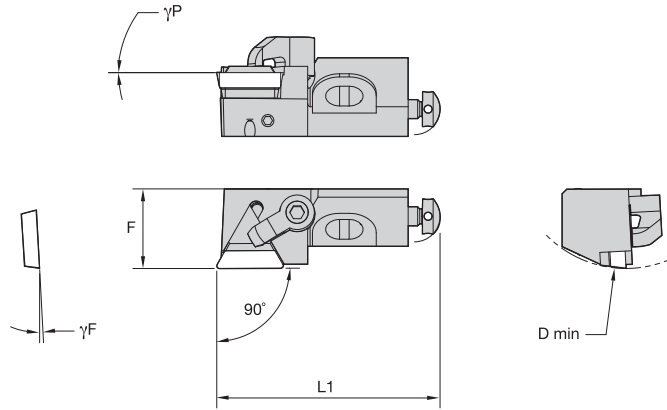
ISO/ANSI Turning



■ CTGP 0°

order number	catalog number	D min	F	L1	γF°	γP°	gage insert
right hand 3330191	CTGPR12CA3	1.969	.787	2.17	3.0	.0	TP..160308/TP..322

■ Spare Parts



D min	shim	clamp	clamp screw	hex	radial adjusting screw	hex	axial adjusting screw	mounting screw	hex	washer
1.969	—	CKM34	STCM38	2 mm	KUAM22	2 mm	KUAM31	191.406	4 mm	CSWM 060 050